

# HOZELOCK

4805  
4807  
4810

## 5L, 7L & 10L Pro



www.hozelock.com

HOZELOCK

HOZELOCK Ltd.  
Midpoint Park, Birmingham,  
B76 1AB, England  
Tel: +44 (0) 121 313 1122

[www.hozelock.com](http://www.hozelock.com)  
33887-000

Contents • Contenu • Inhalt • Inhoud • Contenidos • Innehåll • Innhold • Sisältö • Indhold  
 Indice • Conteúdo • Zawartość • Περιεχόμενα • İçindekiler • Tartalom • Obsah • Содержание  
 Sisukord • Saturs • Turinys • Cuprins • Зміст • Vsebina

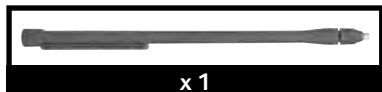
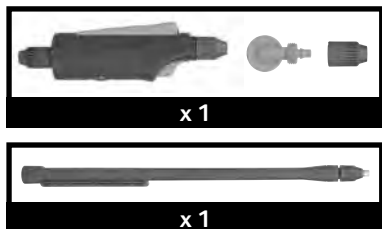

Assembly • Assemblage • Montage • Samenstelling • Montaje • Montering • Monterung  
 Kokoaminen • Montering • Montaggio • Montagem • Montaž • Συγκρότημα • Montaj • Összeszerelés • Sestava  
 Сборка • Koostamine • Montáža • Surinkimas • Ansamblu • Монтаж • Sestav

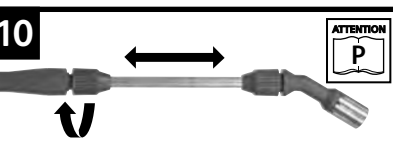
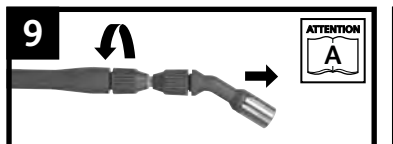
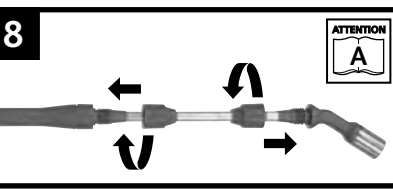
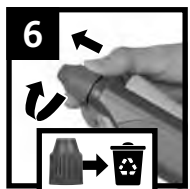
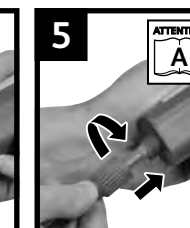
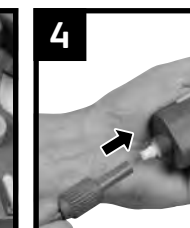
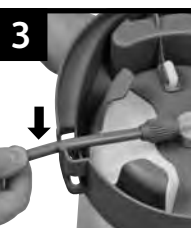
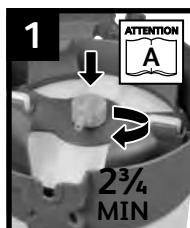

Operation • Fonctionnement • Bedienung • Gebruik • Funcionamiento • Användning • Bruk • Käyttö • Drift • Uso  
 Operação • Обслуга • Λειτουργία • Çalıştırma • Használat • Provoz • Эксплуатация • Kasutamine • Darbība  
 Naudojimas • Operare • Використання • Delovanje

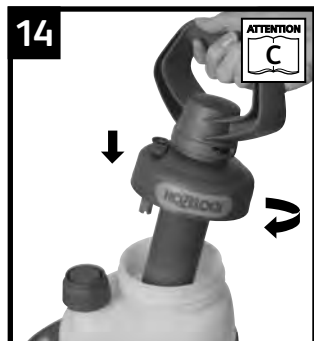

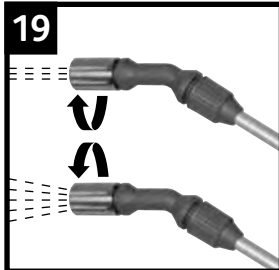
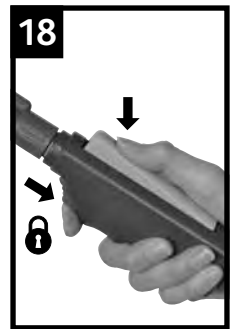
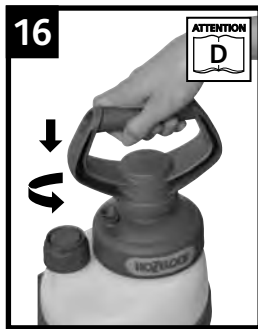

Maintenance • Entretien • Wartung • Onderhoud • Mantenimiento • Underhåll • Vedlikehold • Huolto • Vedligehold  
 Manutenzione • Manutenção • Konserwacja • Συντήρηση • Bakım • Karbantartás • Zdr ba • Техническое обслуживание  
 Hooldamine • Tehniskā aprkope • Prižiūra • Įtretiūre • Обслуговування • Vzdrževanje

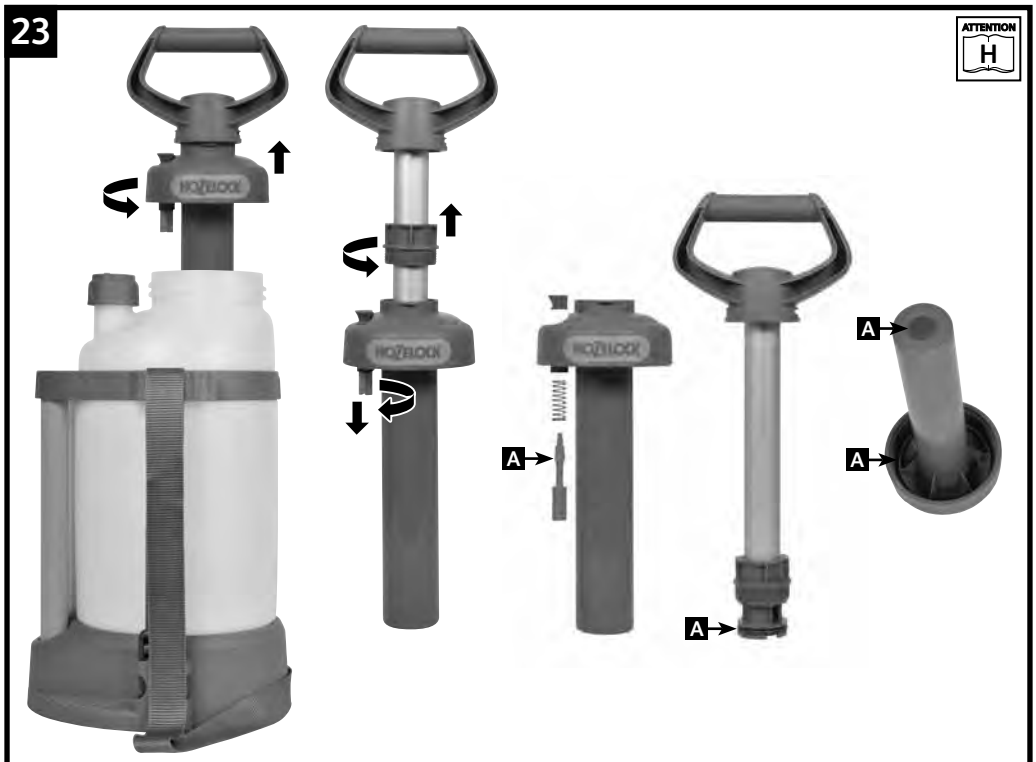

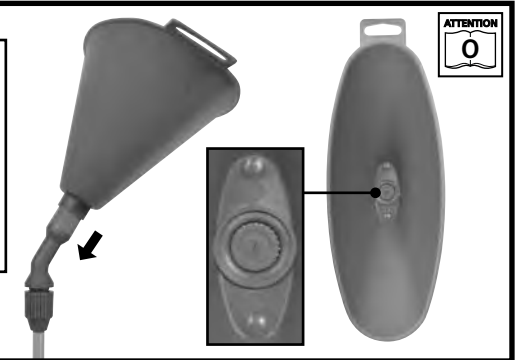
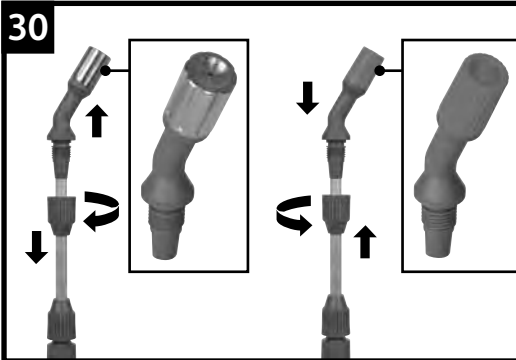
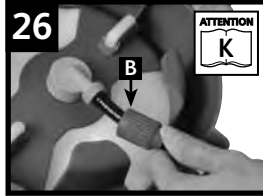
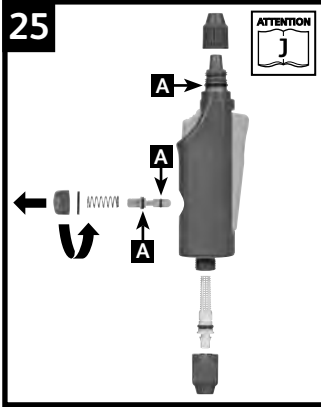
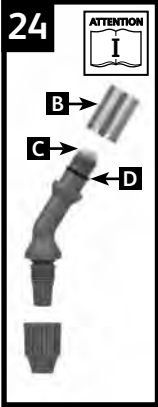

**GB**

Thank you for choosing a Hozelock quality sprayer, you can be assured of many years of reliable service from this product.

**Instructions and Warnings**

- This sprayer is intended for use with water-based solutions of insecticides, fungicides, weedkillers and fertilizers, but as it is fitted with Viton seals, can also be used with more aggressive chemicals, for cleaning, degreasing, disinfecting and stripping, check with the chemical manufacturers if you have any doubt about the suitability of a chemical for spraying. (Viton is a registered trade mark of Dupont).
- Nitric acid, acetic acid and propionic acid must only be used in a concentration of up to 10%, phosphoric acid, and sulphuric acid in a concentration of up to 30%, and potassium hydroxide and caustic soda in a concentration of up to 20%.

**NOT SUITABLE FOR:**

- Combustible liquids with a flashpoint below 55 degrees Celsius.
- Wetting agents (tensides)
- Viscous or sticky liquids or liquids that form residues

(dyes and greases)

- Liquid at temperatures above 30 degrees Celsius.
- Always follow the chemical suppliers instructions, as well as the instructions published with this sprayer.
- Make sure all nuts are screwed hand tight before use.
- If the sprayer has been used with chemicals, discard safely any unused solution after use.
- Always use eye protection when replacing valves, seals or springs
- **Before carrying out any maintenance on this sprayer it is essential to depressurise the bottle, by lifting the pressure release knob.**
  - ⚠ Always wear protective clothing, goggles, face mask and gloves.
  - ⚠ Avoid inhaling spray mist.
  - ⚠ Avoid skin contact with chemicals.
  - ⚠ Always work in a well ventilated area.
  - ⚠ Take care to protect children, pets & fish from exposure to chemicals.
  - ⚠ Always wash hands thoroughly after use & especially before eating.

- A** Always wash any contaminated clothing.
- A** Seek medical attention if spray gets in your eyes or you develop any symptoms after spraying.
- A** Do not spray near food or food preparation areas. When spraying crops, pay particular attention to the chemical manufacturers advice on time before crops can be eaten.
- A** Do not spray any solvent e.g. White spirit.
- A** Spray only thin watery solutions; thicker mixtures will clog the nozzle.
- A** Powdered chemicals can be sprayed successfully if they are completely soluble in water. If they are not, or the solution tends to settle, spraying can still be successful if the mixture is continually agitated.
- A** If the material to be sprayed contains sediment, strain the liquid into the sprayer bottle.
- A** Do not over pressurize the bottle. The pressure release valve is designed to release excess pressure, and must not be tampered with, or forced to remain closed.
- A** Winter use – drain liquid from all parts and loosen pump assembly.
- A** Annual maintenance – At least once per year thoroughly clean the whole sprayer and apply silicone grease to all moving parts & seals. Test with water, and if any washer or seal has perished it must be replaced.

- I** The nozzle cap (B) and swirl grooves (C) should be kept clean and free of obstructions. The 'O' ring seal (D) should be lubricated with silicone grease to allow the spray pattern to be easily changed.
- J** Keep the trigger clean and free from build up of sediment by regularly flushing after use, if necessary remove and clean the shuttle in the trigger (A) using a coin or similar.
- K** To clean or replace the angled adaptor washer, unscrew the retaining nut (B), pull off the hose and unscrew the angled adaptor.
- L** Ensure that the dosing cup last used indicator is set correctly after using the sprayer. To change the setting, remove the dosing cup then align the arrow with the required symbol by lifting and turning the nut.
- M** For storage the hose can be coiled inside the base.
- N** If required the hose maybe clipped into the top trim for storage.
- O** When using the weed killer cone, ensure that the angled head assembly with the red fan spray nozzle is fitted and the nozzle aligned correctly. The red nozzle is not adjustable.
- P** The telescopic lance can be adjusted in length by firstly loosening the lance nut, and retightening as required.

## Notes

- A** Ensure the hose fully covers the barbed details on both the lance, and outlet connector. Make sure all nuts are hand tight before use.
- B** This sprayer is made from many types of plastic, and although the liquid you wish to spray may also be packed in plastic, this does not guarantee it will not damage the sprayer. If you have any doubt about compatibility, contact Hozelock consumer services. When filling the sprayer, or using the dosing cup, always use the large filling aperture, and ensure that the maximum fill level is not exceeded.
- C** Ensure that the pump and dosing cup is screwed into the bottle tightly before pressurising and locked in position.
- D** Before operating the pump, operate the pressure release valve manually by lifting the knob to ensure it is free to move, then release the handle by rotating anticlockwise, pressurise bottle and then lock back in position.
- E** After using the sprayer, manually operate the pressure release valve as above, to depressurise.
- F** If the sprayer has been used with chemicals discard any unused solution in an environmentally friendly manner.
- G** Fill bottle with warm (not hot) water, reassemble the sprayer, and spray some of the contents. Repeat, and check that the nozzle is free from sediment. If necessary, repeat the process until the sprayer is clean. NB: Do not use detergent.
- H** The pump assembly and pressure release valve o rings should be lubricated to allow the sprayer to pump air efficiently. Access the seals by unscrewing the plunger retaining ring. Apply silicone grease regularly to the pump, piston and release valve o ring seals (A).

## Guarantee

- Hozelock guarantees this sprayer against any defect arising from faulty materials or workmanship for a period of 5 years from the date of purchase, provided that it has only been used in accordance with these instructions. The guarantee is limited to the repair or replacement of any defective or faulty item. Proof of purchase must be retained.
- Hozelock extended guarantee covers the bottle and pump mechanism only. It specifically excludes all 'O'-rings & seals. These have a 12-month guarantee, are wearing parts and are available as spares from the retailer or from Hozelock direct.

## Troubleshooting

Issue	Problem	Solution
Weak or no spray	Sprayer will not pressurise	Ensure all connections are tight and the dosing cup is fitted
	Loss of pressure	Check 'O'-rings and seals are lubricated and show no signs of wear or damage – replace if required (see notes H, I, J, and K)
	Obstruction	There could be a blockage in the nozzle, the trigger or the outlet hose
Distorted Spray	Obstruction	There could be debris in the nozzle

Issue	Problem	Solution
Leaks	Build up of sediment or foreign matter on sealing surfaces	Check 'O'-rings and seals are free from dirt – Clean or replace if required
	Worn or damaged 'O' rings or washers	Check 'O'-rings and seals are free from wear or damage – replace if required
Handle rises	Faulty non return valve	This stops the compressed air in the container from escaping back into the pump If faulty, the pump handle will rise when the container is pressurised. To remove the valve, lift the edge and pull (NB take care not to damage the sealing face of the barrel. Replace with a new valve by pushing firmly over the centre hole)

- 1** Complete pump assembly (Viton™) - Part No. 4128
- 2** Angled outlet adaptor assembly (Viton™) - Part No. 4131
- 3** Pressure release valve assembly (Viton™) - Part No. 4132
- 4** Reinforced 2m hose (PVC) - Part No. 4099
- 5** Trigger assembly (Viton™) - Part No. 4135
- 6** Strap assembly - Part No. 4136
- 7** Telescopic lance assembly (Viton™) - Part No. 4107
- 8** Weedkiller cone with fanspray angled head assembly - Part No. 4112
- 9** Annual service kit - Part No. 4126
- 10** Replacement nozzle kit (jet and fan) - Part No. 4133

Please go to [www.hozelock.com](http://www.hozelock.com) for details of spares and accessories available.

**Consumer helpline: 0121 313 1122**

## Spares and Accessories

